

Shaft Shown in Full
C.C.W. Position

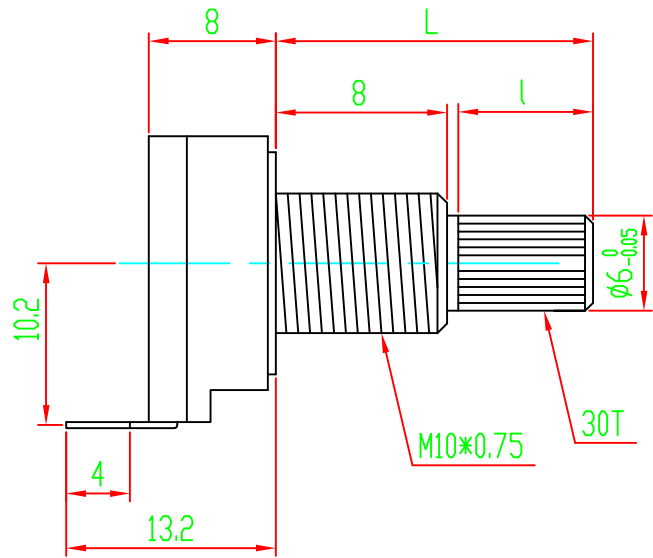
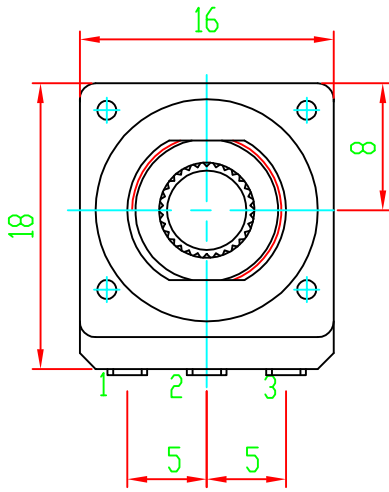

L	19	20	24	30	45
l	8.5	8.5	8.5	16	31.5

02				05			
01				04			
	DATE	REVISION	APPROVED	03			

MODEL: WH0162-1 L20 30T

DRAWING NO:



常州宇豪电子有限公司

CHANGZHOU YUHAO ELECTRONIC CO.,LTD.

DRAW	CHKD	APPD